



**FADINI**  
el abre verjas



Puertas & Portones Automáticos, S.A. de C.V.  
*¡Nuestra pasión es la Solución!...*

» OPERADOR ELECTROMECHANICO CORREDIZO MOD.MEC-200.

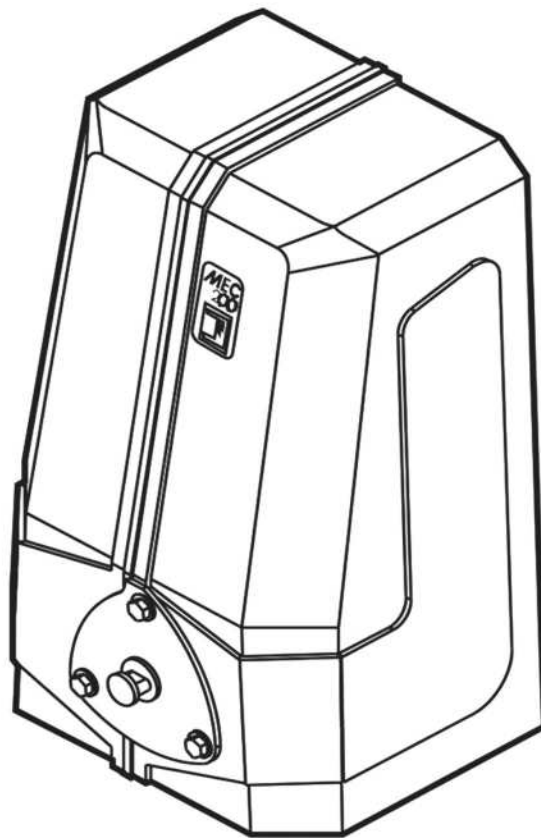

MEC 200 VERTICALE

(229) 288-1552

portonesautomaticos@adsver.com.mx  
portonesautomaticos@prodigy.net.mx



RESIDENCIAL



COMERCIAL



INDUSTRIAL

MEMBER



International Door Association



V07.18

(229) 927-5107, 167-8080, 167-8007, 151-7529



[www.adsver.com.mx](http://www.adsver.com.mx)



**FADINI**  
el abre verjas



Puertas & Portones Automáticos, S.A. de C.V.

*¡Nuestra pasión es la Solución!....*

» OPERADOR ELECTROMECHANICO CORREDIZO MOD.MEC-200.

FADINI® l'apricancello		MEC 200		SP.K17 PEZZI DI RICAMBIO	
RIF. ARTICOLO	FIGURA	POSIZIONE	DENOMINAZIONE	QUANTITA'	CODICE D'ORDINE
20001		<b>1</b> v.o.	Bulloni M10x35 fissaggio basamento con staffa ancoraggio	4	200123
20002		<b>2</b> v.o.	Piastra di ancoraggio 260x120	1	200123
20003		<b>3</b> v.o.	Rondelle ø 10 per basamento	4	200123
20004		<b>4</b> v.o.	Dadi M10 per basamento	4	200123
20005		<b>5</b> v.o.	Viti M8x25 TE per fissaggio basamento carcassa	6	20005
20006		<b>6</b> o.	Basamento mod. 200/15	1	200166
20007		<b>7</b> o.	Guarnizione guarnital da 6 fori	1	200169
20008		<b>8</b> v.o.	Guarnizione OR 4325	1	200169
20009		<b>9</b> v.o.	Cuscinetto radiale 6205	2	200207
20010		<b>10</b> o.	Albero di trascinamento	1	20010



V07.18

(229) 288-1552

portonesautomaticos@adsver.com.mx  
portonesautomaticos@prodigy.net.mx



**IDA**  
International Door Association



(229) 927-5107, 167-8080, 167-8007, 151-7529

www.adsver.com.mx















**FADINI**  
el abre verjas

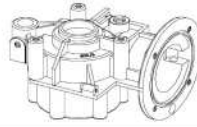

Puertas & Portones Automáticos, S.A. de C.V.  
*¡Nuestra pasión es la Solución!....*

» OPERADOR ELECTROMECHANICO CORREDIZO MOD.MEC-200.

 <b>FADINI</b> l'apricancello		<b>MEC 200</b>		<b>SP.K17</b> PEZZI DI RICAMBIO	
20011		<b>11</b> v.o.	Seeger E25	1	200207
20012		<b>12</b> v.o.	Chiavetta 8x7x20	1	200207
20013		<b>13</b> v.o.	Corona in ottone speciale mod. 200/7	1	200207
20014		<b>14</b> v.o.	Disco di trascinamento mod. 400/5	1	200207
20015		<b>15</b> v.o.	Chiavetta 12x8x47	1	200207
20016		<b>16</b> v.	Carcassa mod. 200/2 verticale	1	20016
20017		<b>17</b> v.o.	Anello di compensazione 52A	1	20017
20018		<b>18</b> o.	Carcassa mod. 200/2 orizzontale	1	20018
20019		<b>19</b> v.o.	Paraolio 25x38x8 (n° 1 pz. per modello orizzontale)	2	200169
20020		<b>20</b> v.o.	Ingranaggio di trascinamento Z18 M4	1	200225
20021		<b>21</b> v.o.	Guarnizione foro 17 tappo olio	1	200169



V07.18

(229) 288-1552

 portonesautomaticos@adsver.com.mx  
portonesautomaticos@prodigy.net.mx



MEMBER



(229) 927-5107, 167-8080, 167-8007, 151-7529



www.adsver.com.mx













**FADINI**  
el abre verjas

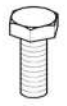
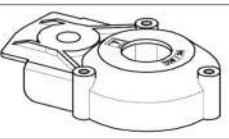

Puertas & Portones Automáticos, S.A. de C.V.  
*¡Nuestra pasión es la Solución!....*

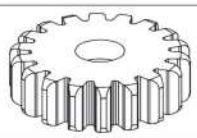
» OPERADOR ELECTROMECHANICO CORREDIZO MOD.MEC-200.

 <b>FADINI</b> l'apricancello		<b>MEC 200</b>		<b>SP.K17</b> PEZZI DI RICAMBIO	
20022		<b>22</b> v.o.	Tappo olio Tao 3/8" gas	1	<b>20022</b>
20023		<b>23</b> v.o.	Grano di fermo M8x16 a punta fissaggio ingranaggio	1	<b>20023</b>
20024		<b>24</b> o.	Spinotto ø 8x42	1	<b>20024</b>
20025		<b>25</b> o.	Vite M10x30 TE sblocco manuale orizzontale	1	<b>20025</b>
20026		<b>26</b> o.	Copri ingranaggio mod. 200/26	1	<b>20026</b>
20027		<b>27</b> o.	Vite speciale M8x77 TE	3	<b>20027</b>
20028		<b>28</b> v.o.	Cartellino d'istruzione "blocco/sblocco"	1	<b>20028</b>
20029		<b>29</b> v.	Prigioniero a gambo esagonale M8x77 <i>(sostituito con codice d'ordine 200122)</i>	3	<b>200122</b>
20030		<b>30</b> o.	Ingranaggio di accoppiamento Z18 M4 - con sede cuscinetto -	1	<b>20030</b>
20031		<b>31</b> o.	Cuscinetto radiale 6204/2RS	1	<b>20031</b>
20032		<b>32</b> v.o.	Rotella con gambo <i>(sostituito con codice d'ordine 2003839)</i>	1	<b>2003839</b>



V07.18

(229) 288-1552

 portonesautomaticos@adsver.com.mx  
portonesautomaticos@prodigy.net.mx



(229) 927-5107, 167-8080, 167-8007, 151-7529

www.adsver.com.mx















**FADINI**  
el abre verjas

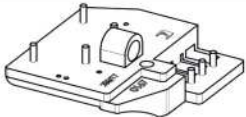

Puertas & Portones Automáticos, S.A. de C.V.  
*¡Nuestra pasión es la Solución!....*

» OPERADOR ELECTROMECHANICO CORREDIZO MOD.MEC-200.

 <b>FADINI</b> l'apricancello		<b>MEC 200</b>		<b>SP.K17</b> PEZZI DI RICAMBIO	
20033		<b>33</b> o.	Albero di rinvio ingranaggio	1	<b>20033</b>
20034		<b>34</b> o.	Grano di fermo albero rinvio a punta cilindrica M8x16B	1	<b>20034</b>
20035		<b>35</b> v.o.	Bollo riferimento potenza	1	<b>20035</b>
20036		<b>36</b> v.o.	Targhetta monofase o trifase	1	<b>20036</b>
20037		<b>37</b> v.o.	Asole di arresto mod. 200/23	2	<b>2002061</b>
20038		<b>38</b> v.o.	Dado M6 fissaggio copri micro	1	<b>2003839</b>
20039		<b>39</b> v.o.	Copri micro mod. 200/18	1	<b>2003839</b>
20040		<b>40</b> v.o.	Vite prigioniera M6x62 copri micro	1	<b>2003839</b>
20041		<b>41</b> v.o.	Microinterruttore	2	<b>2003839</b>
20042		<b>42</b> v.o.	Supporto microcontatti mod. 200/17	1	<b>2003839</b>
20043		<b>43</b> v.o.	Morsettiera a 3 posti	1	<b>2003839</b>



V07.18

(229) 288-1552

 portonesautomaticos@adsver.com.mx  
portonesautomaticos@prodigy.net.mx



(229) 927-5107, 167-8080, 167-8007, 151-7529

www.adsver.com.mx















**FADINI**  
el abre verjas



Puertas & Portones Automáticos, S.A. de C.V.  
*¡Nuestra pasión es la Solución!....*

» OPERADOR ELECTROMECHANICO CORREDIZO MOD.MEC-200.

 <b>FADINI</b> l'apricancello		<b>MEC 200</b>		<b>SP.K17</b> PEZZI DI RICAMBIO	
20044		<b>44</b> v.o.	Fili finecorsa	4	2003839
20045		<b>45</b> o.	Asta flessibile inox ø esterno 10,6x82x1,8 con occhio	1	2003851
20046		<b>46</b> v.o.	Anello di compensazione 47B per vite senza fine <i>(non si usa più)</i>	1	
20047		<b>47</b> v.o.	Guarnizione OR 98x3	2	200169
20048		<b>48</b> v.o.	Cuscinetto radiale 6204	1	20048
20049		<b>49</b> v.o.	Vite senza fine M2,75	1	20049
20050		<b>50</b> v.o.	Chiavetta 6x6x15	1	20050
20051		<b>51</b> v.o.	Cuscinetto radiale 6006	1	20051
20052		<b>52</b> v.o.	Supporto frizione mod. 200/22	1	20052
20053		<b>53</b> v.o.	Prigionieri M8x42 per motore elettrico HP 1,0 - HP 1,5	4	20053
20054		<b>54</b> v.o.	Campana frizione mod. 200/54	1	20054



V07.18

(229) 288-1552

 portonesautomaticos@adsver.com.mx  
portonesautomaticos@prodigy.net.mx



MEMBER  
**IDA**  
International Door Association



(229) 927-5107, 167-8080, 167-8007, 151-7529

www.adsver.com.mx













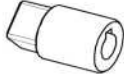

**FADINI**  
el abre verjas

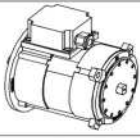

Puertas & Portones Automáticos, S.A. de C.V.  
*¡Nuestra pasión es la Solución!....*

» OPERADOR ELECTROMECHANICO CORREDIZO MOD.MEC-200.

 <b>FADINI</b> l'apricancello		<b>MEC 200</b>		<b>SP.K17</b> PEZZI DI RICAMBIO	
20055		<b>55</b> v.o.	Molla a compressione ø esterno 3,5x38,5x18	1	<b>20055</b>
20056		<b>56</b> v.o.	Giunto speciale con sede quadra e foro ø 14	1	<b>20056</b>
20057		<b>57</b> v.o.	Motore elettrico HP 1,0 trifase mod. 200/4	1	<b>20057</b>
20058		<b>58</b> v.o.	Motore elettrico HP 1,5 trifase mod. 200/5	1	<b>20058</b>
20059		<b>59</b> v.o.	Viti M8x155 TE per motore elettrico HP 0,5 trifase	2	<b>20059</b>
20060		<b>60</b> v.o.	Motore elettrico HP 0,5 trifase mod. 200/1	1	<b>20060</b>
20061		<b>61</b> v.o.	Viti M8x170 TE per motore elettrico HP 0,5 monofase	2	<b>20061</b>
20062		<b>62</b> v.o.	Bullone M8x35 registro frizione	1	<b>20062</b>
20063		<b>63</b> v.o.	Dado M8 blocco registro frizione	1	<b>20063</b>
20064		<b>64</b> v.o.	Guarnizione OR 112	1	<b>200169</b>
20065		<b>65</b> v.o.	Leva di comando mod. 200/65	1	<b>20065</b>

6

(229) 288-1552

 portonesautomaticos@adsver.com.mx  
portonesautomaticos@prodigy.net.mx



MEMBER  
**IDA**  
International Door Association



V07.18

(229) 927-5107, 167-8080, 167-8007, 151-7529



www.adsver.com.mx













**FADINI**  
el abre verjas

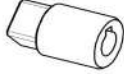

Puertas & Portones Automáticos, S.A. de C.V.  
*¡Nuestra pasión es la Solución!....*

» OPERADOR ELECTROMECHANICO CORREDIZO MOD.MEC-200.

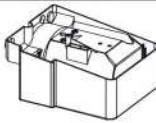
 <b>FADINI</b> l'apricancello		<b>MEC 200</b>		<b>SP.K17</b> PEZZI DI RICAMBIO	
20066		<b>66</b> v.o.	Grano di fermo M8x25 tipo "B"	1	<b>20066</b>
20067		<b>67</b> v.o.	Forcella di leva mod. 200/67	1	<b>20067</b>
20068		<b>68</b> v.o.	Cuscinetto reggispinta 51106	1	<b>20068</b>
20069		<b>69</b> v.o.	Giunto speciale con sede quadra e foro ø 19 mod. 200/69	1	<b>20069</b>
20070		<b>70</b> v.o.	Pressacavo da 1-1/4"	1	<b>2007475</b>
20071		<b>71</b> v.o.	Dischi trazione dentati	4	<b>200223</b>
20072		<b>72</b> v.o.	Dischi frizione con foro quadro	4	<b>200223</b>
20073		<b>73</b> o.	Vite M8x16 TEI di fermo basamento	1	<b>20073</b>
20074		<b>74</b> v.o.	Vite M6x16 TEI di fissaggio contenitore scheda	1	<b>2007475</b>
20075		<b>75</b> v.o.	Rondelle ø 6 per contenitore scheda elettrica	2	<b>2007475</b>
20076		<b>76</b> v.o.	Contenitore scheda elettrica mod. 200/40	1	<b>2007475</b>



V07.18

 (229) 288-1552

 portonesautomaticos@adsver.com.mx  
portonesautomaticos@prodigy.net.mx



(229) 927-5107, 167-8080, 167-8007, 151-7529

[www.adsver.com.mx](http://www.adsver.com.mx)











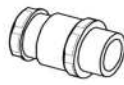
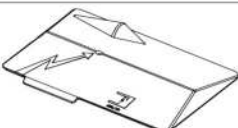

**FADINI**  
el abre verjas



Puertas & Portones Automáticos, S.A. de C.V.  
*¡Nuestra pasión es la Solución!....*

» OPERADOR ELECTROMECHANICO CORREDIZO MOD.MEC-200.

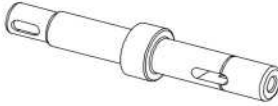
 <b>FADINI</b> l'apricancello		<b>MEC 200</b>		<b>SP.K17</b> PEZZI DI RICAMBIO	
20077		<b>77</b> v.o.	Pressacavo da 3/8"	1	2007475
20078		<b>78</b> v.o.	Coperchio contenitore mod. 200/42	1	2007475
20079		<b>79</b> v.	Dadi M8 fissaggio motore elettrico	4	20079
20080		<b>80</b> o.	Cofano orizzontale	1	20080
20081		<b>81</b> v.o.	Rondelle ø 8	3	20081
20082		<b>82</b> v.o.	Vite M8x20 TE per cofano	3	20082
20083		<b>83</b> v.o.	Tappo cofano	1	2002061
20084		<b>84</b> o.	Chiave di sblocco tubolare da 17	1	2002061
20085		<b>85</b> v.o.	Olio "Oil Fadini" per motoriduttore, fornito in taniche da 2 litri	1	20085
20086		<b>86</b> v.	Basamento angolare mod. 200/14	1	200167
20087		<b>87</b> v.	Albero di trascinamento	1	200207



V07.18

(229) 288-1552

 portonesautomaticos@adsver.com.mx  
portonesautomaticos@prodigy.net.mx



MEMBER  
**IDA**  
International Door Association



(229) 927-5107, 167-8080, 167-8007, 151-7529

www.adsver.com.mx













**FADINI**  
el abre verjas



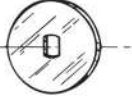

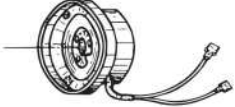

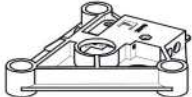





Puertas & Portones Automáticos, S.A. de C.V.  
*¡Nuestra pasión es la Solución!....*

» OPERADOR ELECTROMECHANICO CORREDIZO MOD.MEC-200.

 <b>FADINI</b> l'apricancello		<b>MEC 200</b>		<b>SP.K17</b> PEZZI DI RICAMBIO	
20088		<b>88</b> v.	Vite M10x35 TE speciale sblocco manuale verticale	1	200207
20089		<b>89</b> v.o.	Molla a tazza di compensazione	1	20089
20090		<b>90</b> v.	Asta flessibile inox 10,6x105x1,8	1	2003839
20091		<b>91</b> v.	Cofano verticale	1	20091
20092		<b>92</b> v.	Vite M8x16 TE	1	20092
20093		<b>93</b> v.o.	Disco frenante <i>(non si usa più)</i>	1	
20094		<b>94</b> v.o.	Ancora di attrito <i>(non si usa più)</i>	1	
20095		<b>95</b> v.o.	Molla di compressione <i>(non si usa più)</i>	3	
20096		<b>96</b> v.o.	Massa elettromagnetica <i>(non si usa più)</i>	1	
20097		<b>97</b> v.o.	Vite a brugola M5x20 <i>(non si usa più)</i>	2	
20098		<b>98</b> v.o.	Supporto di sicurezza	1	200206

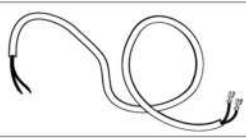

» OPERADOR ELECTROMECHANICO CORREDIZO MOD.MEC-200.

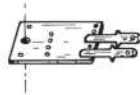
 <b>FADINI</b> l'apricancello		<b>MEC 200</b>		<b>SP.K17</b> PEZZI DI RICAMBIO	
20099		<b>99</b> v.o.	Cucchiaio di stacco micro	1	200206
200100		<b>100</b> v.o.	Dente di stacco micro	1	200206
200101		<b>101</b> v.o.	Spinotto ø 3x46	1	200206
200102		<b>102</b> v.o.	Microinterruttore	1	200206
200103		<b>103</b> v.o.	Molla a compressione 0,5x6,5x25 inox	2	200206
200104		<b>104</b> v.o.	Cavo stacco bassa tensione	1	200206
200105		<b>105</b> v.o.	Vite M3x15 TC	1	200206
200106		<b>106</b> v.o.	Dado M3 - 5587	1	200206
200107		<b>107</b> v.o.	Morsetto a 2 posti <i>(non si usa più)</i>	1	
200108		<b>108</b> v.o.	Contenitore fusibile <i>(non si usa più)</i>	1	
200109		<b>109</b> v.o.	Scheda completa di faston <i>(non si usa più)</i>	1	

10















**FADINI**  
el abre verjas

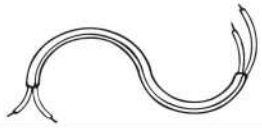
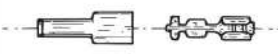

Puertas & Portones Automáticos, S.A. de C.V.  
*¡Nuestra pasión es la Solución!....*

» OPERADOR ELECTROMECHANICO CORREDIZO MOD.MEC-200.

 <b>FADINI</b> l'apricancello		<b>MEC 200</b>		<b>SP.K17</b> PEZZI DI RICAMBIO	
200110		<b>110</b>	Raddrizzatore v.o. <i>(non si usa più)</i>	1	
200111		<b>111</b>	Supporto fusibile v.o. <i>(non si usa più)</i>	1	
200112		<b>112</b>	Fusibile 1 A v.o. <i>(non si usa più)</i>	1	
200113		<b>113</b>	Coperchio porta fusibile v.o. <i>(non si usa più)</i>	1	
200114		<b>114</b>	Vite M5x30 TEI v.o. <i>(non si usa più)</i>	1	
200115		<b>115</b>	Cavo elettrico da 300 mm v.o. <i>(non si usa più)</i>	1	
200116		<b>116</b>	Faston e copri v.o. <i>(non si usa più)</i>	2	
200117		<b>117</b>	Seeger E14 v.	3	200206
200118		<b>118</b>	Adesivo "autofrenante" v.o.	1	200118
200119		<b>119</b>	Tubetto in gomma v.o. <i>(non si usa più)</i>	1	
		<b>120</b>			

11

 (229) 288-1552

 portonesautomaticos@adsver.com.mx  
portonesautomaticos@prodigy.net.mx



MEMBER  
**IDA**  
International Door Association



V07.18

(229) 927-5107, 167-8080, 167-8007, 151-7529



www.adsver.com.mx

» OPERADOR ELECTROMECHANICO CORREDIZO MOD.MEC-200.

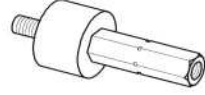
 <b>FADINI</b> l'apricancello		<b>MEC 200</b>		<b>SP.K17</b> PEZZI DI RICAMBIO	
		<b>121</b>			
200122		<b>122</b> v.	Supporto speciale SH 60 40x30 M8 SP 20	3	200122
200124		<b>124</b> v.o.	Vite M6x16 TE fissaggio contenitore scheda	2	2007475
200125		<b>125</b> v.o.	Cartellino d'istruzione registro frizione	1	200125
200126		<b>126</b> v.	Supporto speciale SH 60 30x20 M8 SP 23 solo con programmatore	1	200126
200127		<b>127</b> v.	Pignone di trascinamento Z24 M4	1	200127
200128		<b>128</b> v.	Copri ingranaggio	1	200128
200129		<b>129</b> v.	Vite M8x50 TEI	2	200129
200130		<b>130</b> v.o.	Puntale per molla-finecorsa <i>(sostituito con codice d'ordine 2003839)</i>	1	2003839
200131		<b>131</b> v.	Guarnizione OR 2300	1	200169
200132		<b>132</b> v.o.	Guarnizione OR 2081	1	2002061













**FADINI**  
el abre verjas

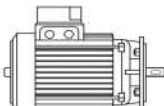

Puertas & Portones Automáticos, S.A. de C.V.  
*¡Nuestra pasión es la Solución!....*

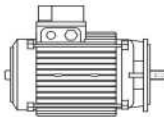
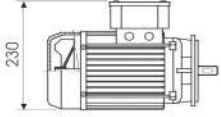
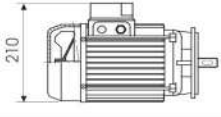
» OPERADOR ELECTROMECHANICO CORREDIZO MOD.MEC-200.

 <b>FADINI</b> l'apricancello		<b>MEC 200</b>		<b>SP.K17</b> PEZZI DI RICAMBIO	
200133		<b>133</b> v.o.	Guarnizione OR 8x1	1	200169
200134		<b>134</b> v.o.	Rotella in plastica per molla finecorsa	1	2003839
200135		<b>135</b> v.o.	Coperchio basetta motore elettrico trifase CV 1,0 - 1,5	1	200135
200136		<b>136</b> v.o.	Motore elettrico <b>900 giri/min</b> CV 1,5 trifase Rif. dis. 5320	1	200136
200137		<b>137</b> v.o.	Fondello a scudo con freno motore elettrico e ferodo	1	200137
200138		<b>138</b> v.o.	Motore elettrico <b>900 giri/min</b> CV 1,0 trifase Rif. dis. 6249	1	200138
200139		<b>139</b> v.o.	Motore elettrico <b>700 giri/min</b> CV 0,5 monofase Rif. dis. 3353	1	200139
200140		<b>140</b> v.o.	Motore elettrico <b>700 giri/min</b> CV 0,5 trifase Rif. dis. 3354	1	200140
200142		<b>142</b> v.o.	Coperchio motore elettrico per: CV 1,0 e 1,5 trifase CV 1,0 monofase	1	200142
200143		<b>143</b>	Cavo di collegamento finecorsa al programmatore interno (3 fili, l = 540 mm)		200143

13

(229) 288-1552

 portonesautomaticos@adsver.com.mx  
portonesautomaticos@prodigy.net.mx



MEMBER  
**IDA**  
International Door Association



V07.18

(229) 927-5107, 167-8080, 167-8007, 151-7529



www.adsver.com.mx



**FADINI**  
el abre verjas



Puertas & Portones Automáticos, S.A. de C.V.  
*¡Nuestra pasión es la Solución!....*

» OPERADOR ELECTROMECHANICO CORREDIZO MOD.MEC-200.

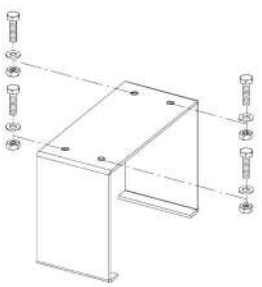
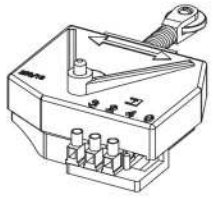
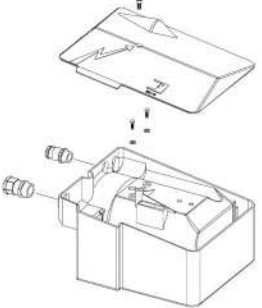
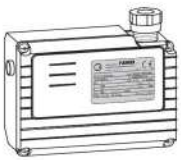
FADINI® l'apricancello		MEC 200	SP.K17 PEZZI DI RICAMBIO
RIF. ARTICOLO	FIGURA	DENOMINAZIONE	CODICE D'ORDINE
200123		Piastra di ancoraggio completa di bulloni, dadi e rondelle: art. 1-2-3-4	200123
2003839	 Verticale	Finecorsa completo di: art. 38-39-40-41-42-43-44-90-134  <i>(Rotella in plastica)</i>	2003839
2007475		Contenitore programmatore elettronico completo di: art. 70-74-75-76-77-78-124	2007475
200264		Completo scatola porta morsettiera e condensatore, con coperchio e n° 4 viti autofilettanti 3,9x16 TC <i>(per motore elettrico CV 1,0 monofase)</i>	200264

14



V07.18

(229) 288-1552

portonesautomaticos@adsver.com.mx  
portonesautomaticos@prodigy.net.mx



RESIDENCIAL



COMERCIAL



INDUSTRIAL

MEMBER



International Door Association



(229) 927-5107, 167-8080, 167-8007, 151-7529

www.adsver.com.mx



**FADINI**  
el abre verjas



Puertas & Portones Automáticos, S.A. de C.V.  
*¡Nuestra pasión es la Solución!....*

» OPERADOR ELECTROMECHANICO CORREDIZO MOD.MEC-200.

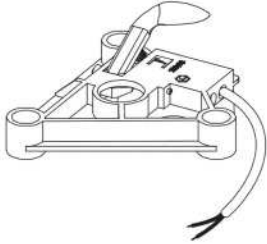
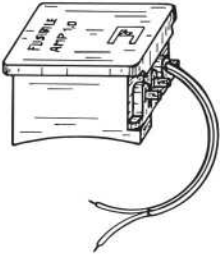
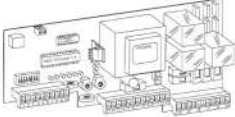
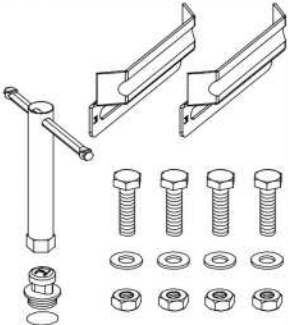
FADINI® l'apricancello		MEC 200	SP.K17 PEZZI DI RICAMBIO
RIF. ARTICOLO	FIGURA	DENOMINAZIONE	CODICE D'ORDINE
200206		Supporto di sicurezza completo di: art. 98-99-100-101-102-103-104-105-106-117	200206
20010810		Contenitore fusibile completo di: art. 108-109-110-111-112-113-114-115-116  <i>(non si usa più)</i>	
200060		Programmatore elettronico 70/3 da inserire nel Mec 200	200060
2002061		Confezione asole di finecorsa, bulloni, rondelle, dadi, chiave, tappo cofano e OR: art. 1-3-4-37-83-84-132	2002061

15

(229) 288-1552

 portonesautomaticos@adsver.com.mx  
portonesautomaticos@prodigy.net.mx



RESIDENCIAL



COMERCIAL



INDUSTRIAL

MEMBER



International Door Association



V07.18

(229) 927-5107, 167-8080, 167-8007, 151-7529



www.adsver.com.mx





**FADINI**  
el abre verjas



Puertas & Portones Automáticos, S.A. de C.V.  
*¡Nuestra pasión es la Solución!....*

» OPERADOR ELECTROMECHANICO CORREDIZO MOD.MEC-200.

FADINI® l'apricancello		MEC 200	SP.K17 PEZZI DI RICAMBIO
RIF. ARTICOLO	FIGURA	DENOMINAZIONE	CODICE D'ORDINE
200207		<p>Gruppo albero di trascinamento completo di:</p> <ul style="list-style-type: none"> <li>- Albero di trascinamento art. 87</li> <li>- Cuscinetti radiali 6205 art. 9</li> <li>- Corona Z32 art. 13</li> <li>- Disco di sblocco assiale art. 14</li> <li>- Chiavetta 12x8x47 art. 15</li> <li>- Anello seeger E25 art. 11</li> <li>- Vite speciale di sblocco art. 88</li> </ul>	200207
2003851	 Orizzontale	<p>Finecorsa completo di: art. 38-39-40-41-42-43-44-45-134</p> <p><i>(Rotella in plastica)</i></p>	2003851
200164		<p>Scatola per imballo completa di: n° 2 pz. di cartoncino, n° 2 pz. di polistirolo e n° 1 pz. di polistirolo sagomato</p> <p><i>Verticale - Orizzontale</i></p>	200164
200165		<p>Scatola per imballo completa di: n° 2 pz. di cartoncino e n° 2 pz. di polistirolo</p> <p><i>Orizzontale</i></p> <p><i>(sostituito con codice d'ordine 200164)</i></p>	200164







**FADINI**  
el abre verjas

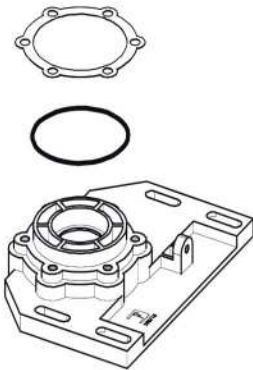
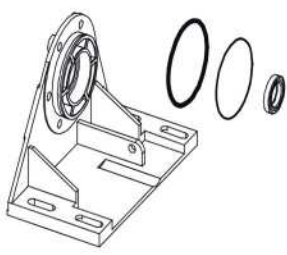

Puertas & Portones Automáticos, S.A. de C.V.  
*¡Nuestra pasión es la Solución!....*

» OPERADOR ELECTROMECHANICO CORREDIZO MOD.MEC-200.

FADINI® l'apricancello		MEC 200	SP.K17 PEZZI DI RICAMBIO
RIF. ARTICOLO	FIGURA	DENOMINAZIONE	CODICE D'ORDINE
200166		Basamento orizzontale mod. 200/15, completo di guarnizioni. Art. 6-7-8	200166
200167		Basamento verticale mod. 200/14, completo di guarnizioni e paraolio. Art. 8-19-86-131	200167
200169		Confezione serie guarnizioni, completa di art: 7-8-19-21-47-64-131-133	200169

17

 (229) 288-1552

 portonesautomaticos@adsver.com.mx  
portonesautomaticos@prodigy.net.mx



RESIDENCIAL



COMERCIAL



INDUSTRIAL

MEMBER



International Door Association



V07.18







**FADINI**  
el abre verjas

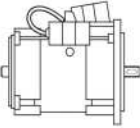
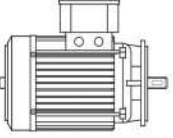
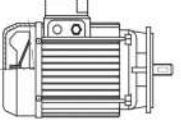
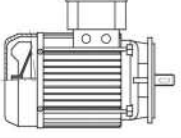
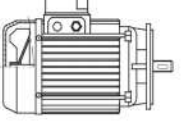

Puertas & Portones Automáticos, S.A. de C.V.  
*¡Nuestra pasión es la Solución!....*

» OPERADOR ELECTROMECHANICO CORREDIZO MOD.MEC-200.

 <b>FADINI</b> l'apricancello		<b>MEC 200</b>		<b>SP.K17</b> PEZZI DI RICAMBIO	
200191		<b>191</b> v.o.	Motore elettrico monofase <b>CV 0,5</b>	1	200191
200192		<b>192</b> v.o.	Motore elettrico monofase <b>CV 1,0</b>	1	200192
200193		<b>193</b> v.o.	Motore elettrico trifase, ventilato, con freno <b>CV 1,0</b>	1	200193
200194		<b>194</b> v.o.	Motore elettrico monofase, ventilato, con freno <b>CV 1,0</b>	1	200194
200195		<b>195</b> v.o.	Motore elettrico trifase, ventilato, con freno <b>CV 1,5</b>	1	200195
200212		<b>212</b> v.o.	Ingranaggio <b>Z 18 - m 4,0</b> (p 12,5) L= 50 mm - foro per albero ø 22 mm con grano (Rif. dis. 4504)	1	200212
200213		<b>213</b> v.o.	Ingranaggio <b>Z 20 - m 4,0</b> (p 12,5) L= 45 mm - foro per albero ø 22 mm con grano (Rif. dis. 4505)	1	200213
200214		<b>214</b> v.o.	Ingranaggio <b>Z 15 - m 4,0</b> (p 12,5) L= 30 mm - foro per albero ø 22 mm con grano (Rif. dis. 4506)	1	200214
200215		<b>215</b> v.o.	Ingranaggio <b>Z 12 - m 6,0</b> (p 18,8) L= 30 mm - foro per albero ø 22 mm con grano (Rif. dis. 5666)	1	200215

19

 (229) 288-1552

 portonesautomaticos@adsver.com.mx  
portonesautomaticos@prodigy.net.mx



V07.18





**FADINI**  
el abre verjas



Puertas & Portones Automáticos, S.A. de C.V.  
*¡Nuestra pasión es la Solución!....*

» OPERADOR ELECTROMECHANICO CORREDIZO MOD.MEC-200.

FADINI® l'apricancello		MEC 200		SP.K17 PEZZI DI RICAMBIO	
RIF. ARTICOLO	FIGURA	DENOMINAZIONE		CODICE D'ORDINE	
200217		<b>217</b> v.o.	Ingranaggio <b>Z 22 - m 4,0</b> (p 12,5) L= 45 mm - foro per albero ø 22 mm con grano (Rif. dis. 6331)	1	200217
200218		<b>218</b> v.o.	Ingranaggio <b>Z 26 - m 4,0</b> (p 12,5) L= 45 mm - foro per albero ø 22 mm con grano (Rif. dis. 6335)	1	200218
200219		<b>219</b> v.o.	Ingranaggio <b>Z 20 - m 4,0</b> (p 12,5) L= 25 mm - foro per albero ø 22 mm con grano (Rif. dis. 6691)	1	200219
200220		<b>220</b> v.o.	Ingranaggio <b>Z 18 - m 4,0</b> (p 12,5) L= 45 mm - foro per albero ø 22 mm con grano (Rif. dis. 6745)	1	200220
200221		<b>221</b> v.o.	Ingranaggio <b>Z 18 - m 4,0</b> (p 12,5) L= 20 mm - foro per albero ø 22 mm con grano (Rif. dis. 6749)	1	200221
200223		Kit dischi frizione per <b>Mec 200 verticale</b> , completo di art: 71-72		200223	
200224		Kit dischi frizione per <b>Mec 200 orizzontale</b> , completo di art: 71-72		200224	
200225		Ingranaggio di trascinamento Z18 M4 con grano di fermo M8x16 a punta; art: 20-23		200225	

20

(229) 288-1552

portonesautomaticos@adsver.com.mx  
portonesautomaticos@prodigy.net.mx



RESIDENCIAL



COMERCIAL



INDUSTRIAL

MEMBER



International Door Association



V07.18